

Buttress Style Product Overview

Features:

These workholding clamps are designed for use on thin or low-profile workpieces replacing ordinary strap clamps. They feature a self-aligning swiveling pivot which allows the tightening bolt to always remain vertical, preventing any side forces. The two-point contact offered by Models T614-0 and T614-1 also provides greater stability to the workpiece. Ideally suited for manual die clamping. Eliminates the need for step blocks or riser blocks.



Buttress Style Technical Information, Holding Capacities

Holding Capacity	Working Height Range	For screw diameter	Model	Weight [lbs.] kg
<p>[2900 lbf] 13000N</p>	<p>[0-1.75"] 0-45</p>	<p>[1/2"] M12</p>	T614-0	<p>[1.5] 0,6</p>
<p>[14000 lbf] 62500N</p>	<p>[0-2.25"] 0-57</p>	<p>[5/8"] M16 or [3/4"] M20</p>	T614-1	<p>[5.8] 2,7</p>
<p>[18000 lbf] 80000N</p>	<p>[0-3.00"] 0-75</p>	<p>[1"] M24</p>	T614-2	<p>[9.5] 4,3</p>

Buttress Style Standard Clamp Dimensions

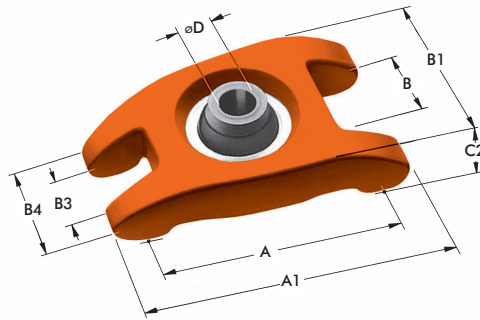

Holding capacity [2900 lbf] 13kN
Clamping height [1.75] 45mm max.
Model T614-0

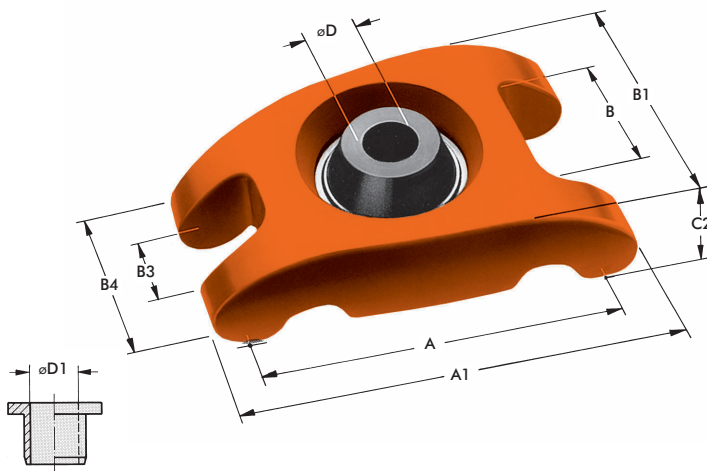
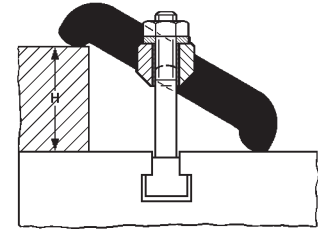

Holding capacity [14000 lbf] 62.5kN
Clamping height [2.25] 57mm max.
Model T614-1
Delivery includes reducing bush with inner diameter 17 [0.67].
Reducer bushing is standard equipment

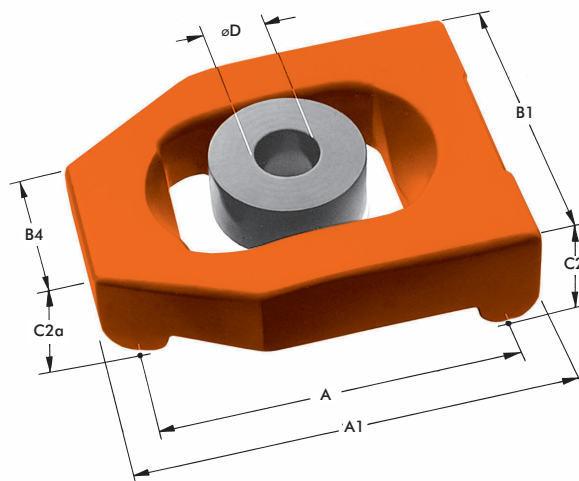
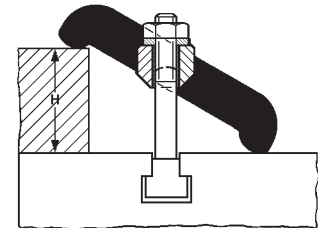

Holding capacity [18000 lbf] 80kN
Clamping height 75 [3.00] max.
Model T614-2

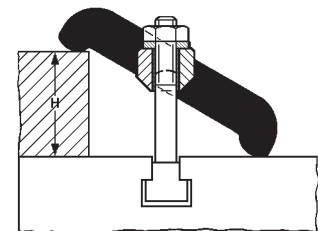

Model	[inch] mm									
	A	A1	B	B1	B3	B4	C2	C2a	ØD	ØD1
T614-0	[3.54] 90	[4.34] 110	[1.41] 36	[2.59] 66	[0.78] 40	[1.56] 40	1.02 26	-	[0.51] 13	-
T614-1	[5.28] 134	[6.31] 160	[2.09] 53	[3.94] 100	[1.14] 29	[2.56] 65	[1.81] 46	-	[0.83] 83	[0.67] 17
T614-2	[5.83] 148	[6.69] 170	-	[5.13] 130	-	[2.56] 65	[1.97] 50	[1.57] 40	[1.02] 26	-